

R&S® ZVAX24 Extension Unit Quick Start Guide



1312.7985.62 – 03

This Quick Start Guide describes the "Extension Unit" R&S® ZVAX24, order no. 1311.2509K02, and the following options:

- "Low Noise Preamplifier" R&S® ZVAX-B203, order no. 1311.2515.02
- "Port 2 Receiver Monitor Output" R&S® ZVAX-B210, order no. 1311.2521.02
- "Combiner" R&S® ZVAX-B211, order no. 1311.2538.02
- "Harmonic Filter Generator Port 1" R&S® ZVAX-B251, order no. 1311.2544.02
- "Harmonic Filter Receiver Port 2" R&S® ZVAX-B252, order no. 1311.2550.02
- "Harmonic Filter Generator Port 3" R&S® ZVAX-B253, order no. 1311.2567.02
- "Pulse Modulator Generator Port 1" R&S® ZVAX-B271, order no. 1311.2573.02
- "Pulse Modulator Receiver Port 2" R&S® ZVAX-B272, order no. 1311.2580.02
- "Pulse Modulator Generator Port 3" R&S® ZVAX-B273, order no. 1311.2596.02
- "High Power Coupler Port 1" R&S® ZVAX-B291, order no. 1311.2609.02
- "High Power Coupler Port 2" R&S® ZVAX-B292, order no. 1311.2615.02

© 2011 Rohde & Schwarz GmbH & Co. KG

Muehldorfstr. 15, 81671 Munich, Germany

Phone: +49 89 41 29 - 0

Fax: +49 89 41 29 12 164

E-mail: info@rohde-schwarz.com

Internet: <http://www.rohde-schwarz.com>

Printed in Germany – Subject to change – Data without tolerance limits is not binding.

R&S® is a registered trademark of Rohde & Schwarz GmbH & Co. KG.

Trade names are trademarks of the owners.

The following abbreviations are used throughout this guide: R&S® ZVAX24 is abbreviated as R&S ZVAX24. Options R&S® ZVAX-Bxxx are abbreviated as R&S ZVAX-Bxxx. The vector network analyzer R&S® ZVA24 is abbreviated as R&S ZVA24.

Contents

1	Safety Instructions	5
2	Preparing the Extension Unit for Use	7
2.1	Front Panel Tour	7
2.1.1	Standby Key	7
2.1.2	USB Connectors	7
2.1.3	RF Connectors	8
2.2	Rear Panel Tour	13
2.2.1	Mains Connector and Switch	13
2.2.2	USB FROM NWA	13
2.2.3	Master USB Connectors	14
2.2.4	FILTER CONTROL IN	14
2.2.5	PORT 1 / 2 / 3 SOURCE	14
2.2.6	CASCADE IN	14
2.2.7	EXT PULSE GENERATOR IN / OUT	15
2.3	Putting the Extension Unit into Operation	15
2.3.1	Unpacking the Extension Unit	15
2.3.2	Instrument Setup	16
2.3.3	Bench Top Operation	16
2.3.4	Mounting the Extension Unit in a 19" Rack	17
2.3.5	EMI Protective Measures	18
2.3.6	Connecting the Extension Unit to the AC Supply	18
2.3.7	Power on and off	18
2.3.8	Standby and Ready State	18
2.3.9	Replacing Fuses	19
2.4	Maintenance	19
2.5	Storing and Packing	20
3	Pulse Profile Measurement	21
3.1	Required Equipment	21
3.2	Measurement Principle	21
3.3	Connecting the Extension Unit	22
3.4	ZVAX Path Configuration	23

3.5	Pulse Generator Signals.....	24
3.6	Pulse Profile Mode.....	26
3.7	Calibration.....	26
3.8	Measurement.....	26
3.9	Possible Extensions.....	27
3.10	Additional Information.....	28
4	Overview of R&S ZVAX24 Options.....	29
	Index.....	30

1 Safety Instructions

This R&S ZVAX24 extension unit has been designed and tested in accordance with the EC Certificate of Conformity and has left the manufacturer's plant in a condition fully complying with safety standards.

CAUTION

General safety instructions

To maintain this condition and to ensure safe operation, you must observe all instructions and warnings given in this Quick Start Guide: Please notice in particular the instructions below on this page and in chapter 2.

RF Connection

The extension unit is intended to be operated with an R&S ZVA24 network analyzer. The maximum RF input powers of the extension unit are beyond the RF output power range of the R&S ZVA24, so there is no risk of damage if it is connected to the test ports **with no external amplifiers or other active devices** in the test setup. Notice, however, the following items:

- Always connect the extension unit as described in [chapter 2.1.3, "RF Connectors"](#), on page 8.
- The "High Power Coupler Port 1 / 2" options (R&S ZVAX24-B91 / -B92) extend the source power range at port 1 and the receiver power range at port 2. External amplifiers may be used to boost the RF powers. Notice the maximum RF powers of the extension unit and the network analyzer quoted in the data sheets. Moreover, observe that maximum RF powers are allowed only if the following conditions are fulfilled:
 - The quoted power handling capability refers to the couplers only. In order to prevent damage to other components of the extension unit and/or the network analyzer, the use of external attenuators and/or isolators may be necessary.
 - None of the options R&S ZVAX-B203, "Low Noise Preamplifier", R&S ZVAX-B252, "Harmonic Filter Source Port 2", and R&S ZVAX-B272, "Pulse Modulator Source Port 2", is switched into the RF signal path of port 2.
 - The signal fed in at the 3.5 mm test port connectors of the high power couplers must not contain a DC offset, as this may impair the measurements and even cause damage to the extension unit.
- Observe the maximum nominal input power of the "Low Noise Preamplifier" quoted in the R&S ZVAX24 data sheet.

ESD Protective Measures

To protect the extension unit against damage due to Electrostatic Discharge (ESD) use the wrist strap and grounding cord supplied with the network analyzer and connect yourself to the GND connector at the front panel. For details refer to the Quick Start Guide of your analyzer.

USB Connection to the Analyzer

- The extension unit is intended for direct connection to R&S ZVA24 network analyzers according to the instructions in [chapter 2.2.2, "USB FROM NWA"](#), on page 13 and in the analyzer's help system. Do not connect the unit to other USB hosts, e.g. a PC, or insert any USB hubs between the analyzer and the unit, as this may cause damage to the unit or the host.
- It is safe to connect or disconnect the extension unit while the network analyzer is operating. Never connect the unit during a firmware update.

2 Preparing the Extension Unit for Use

This chapter gives an overview of the front panel controls and connectors of the R&S ZVAX24 extension unit and gives all information that is necessary to put the unit into operation and connect it to the network analyzer.

Chapter 3, [Pulse Profile Measurement](#) outlines a typical application example for the extension unit (pulse profile measurement). Chapter 4, [Overview of R&S ZVAX24 Options](#) describes the available options and their use. For further information including remote control reference refer to the online help system of your network analyzer or its printed/printable version delivered on CD-ROM.

2.1 Front Panel Tour

The front panel of the extension unit provides the standby key, two type A USB connectors, and RF connectors for ports 1, 2, and 3.

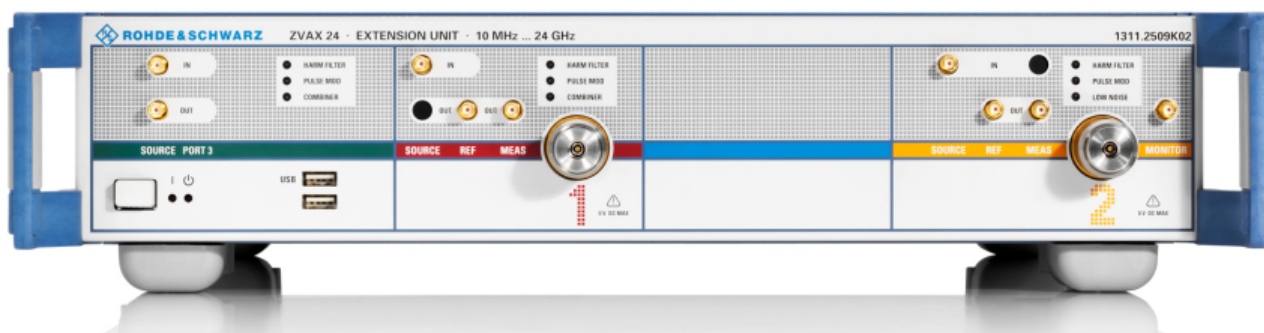

2.1.1 Standby Key



The standby key connects/disconnects all internal modules of the extension unit to/from the DC supply voltages generated by its internal power supply.

The two LEDs indicate whether the extension unit is ready to operate (green LED on) or in standby state (yellow LED on).



It is recommendable to switch the extension unit to standby state or switch it off by the rear panel AC power switch if it is not used for some time.

2.1.2 USB Connectors

The USB connectors of type A (master USB) may be used to connect e.g. a calibration unit, a keyboard, mouse or other pointing devices, a printer or an external storage device (USB stick, CD-ROM drive etc.). A second pair of equivalent USB connectors is located on the rear panel of the extension unit.



When the extension unit is connected to the network analyzer via the type B USB connector on the rear panel of the extension unit, the USB connectors on the front and rear panel of the extension unit are functionally equivalent to those of the network analyzer. For the USB connection between the two instruments, see also [chapter 2.2.2, "USB FROM NWA"](#), on page 13.



The length of the connecting USB cables should not exceed 1 m. The maximum current per USB port is 500 mA.

2.1.3 RF Connectors

The extension unit provides three groups of RF connectors that are located in color-coded areas on the front panel. The colors indicate the corresponding network analyzer ports that are modified in their functionality.

An RF connection to any of the network analyzer ports requires option R&S ZVA24-B16, "Direct Generator/Receiver Access" on the analyzer side.

NOTICE

RF emissions

To comply with the emission requirements, always use semirigid cables (preferably, the cables supplied by Rohde & Schwarz) to connect the extension unit to the network analyzer. Use double-shielded measurement cables for connections to the 3.5 mm test port connectors PORT 1 and PORT 2 and the MONITOR output.

2.1.3.1 RF Connectors Port 1

The Port 1 connectors allow components inside the extension unit to be looped into the RF signal path of the network analyzer (NWA) test port 1. The connectors must be connected to the corresponding connectors provided by the NWA option R&S ZVA24-B16 (see [chapter 2.1.3.4, "Rules for RF Connections"](#), on page 12).

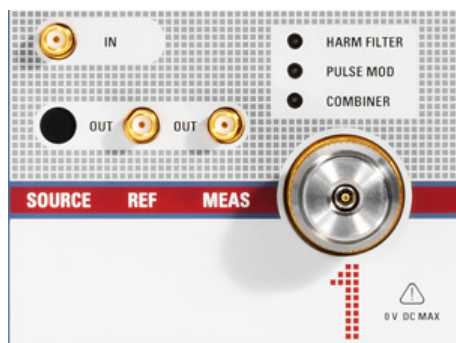

The following connectors are available:

- Two 2.92 mm connectors SOURCE IN and SOURCE OUT. To modify the source signal from analyzer port 1, connect the 2.92 mm connectors as follows:

- SOURCE IN (ZVAX) to SOURCE OUT (NWA)
- SOURCE OUT (ZVAX) to SOURCE IN (NWA)

This type of connection is used in the application example of [chapter 3, "Pulse Profile Measurement"](#), on page 21.

- Option R&S ZVAX-B291, "High Power Coupler Port 1", provides two additional 2.92 mm connectors labeled REF OUT and MEAS OUT plus a 3.5 mm test port connector PORT 1. The SOURCE OUT connector is not installed. This option extends the source power range to values up to 20 W (+43 dBm) at the PORT 1 connector. The "High Power Coupler Port 1" replaces the internal coupler at the network analyzer port 1. The PORT 1 connector replaces the respective test port connector of the network analyzer. To provide a high-power RF source signal at the PORT 1 connector and measure the input signal at PORT 1, connect the extension unit as follows:
 - SOURCE IN (ZVAX) to SOURCE OUT (NWA). To boost the NWA source power, loop an external amplifier into the source signal path using the PORT 1 SOURCE 2.92 mm connectors on the rear panel.
 - REF OUT (ZVAX) to REF IN (NWA). It may be necessary to loop an external attenuator (at least 33 dB for 43 dBm max power) into this connection.
 - MEAS OUT (ZVAX) to MEAS IN (NWA). It may be necessary to loop an external attenuator (at least 33 dB for 43 dBm max power) into this connection.
 - 3.5 mm test port connector (ZVAX) to the input of the DUT

In the figure below, red lines denote signal paths where the power may exceed the maximum input power of the network analyzer.

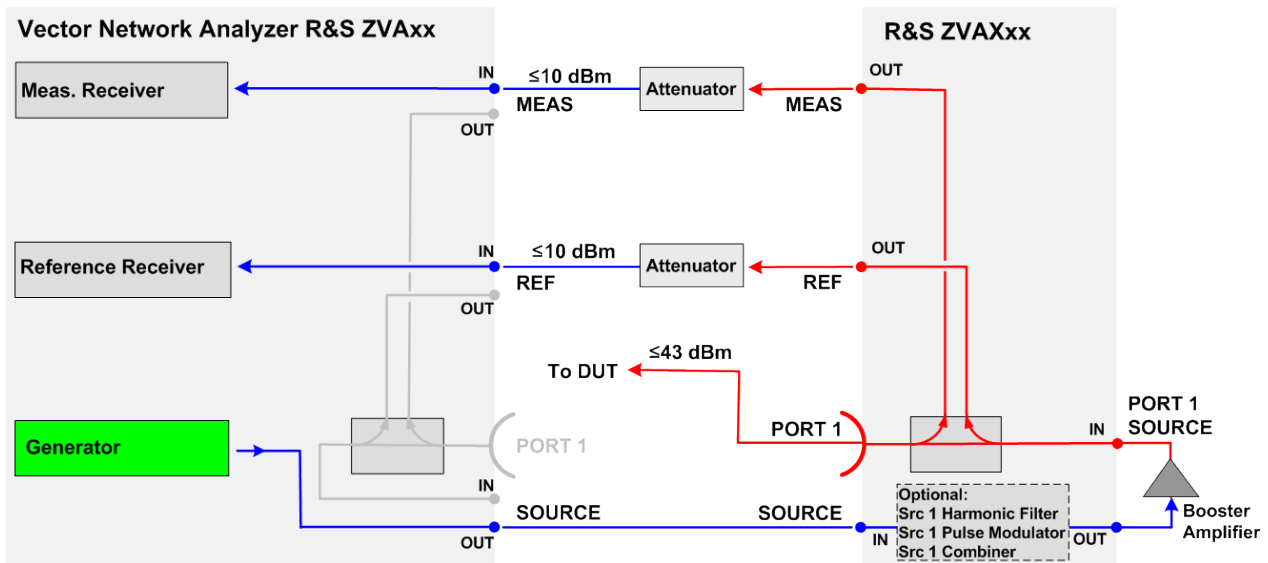

Fig. 2-1: Connection of PORT 1 for high source powers

NOTICE**Maximum RF power and DC offset**

Please observe the maximum RF output power at PORT 1 of the extension unit and the maximum RF input power at the network analyzer ports (see data sheets). If the DUT provides a high input power at the 3.5 mm test port connector of the extension unit, external attenuators may be needed to prevent excess input power at REF IN and MEAS IN (NWA).

In addition, it is important that the signal fed in at the 3.5 mm test port connector contains no DC offset, as this may impair the measurements and even cause damage to the extension unit.

2.1.3.2 RF Connectors Port 2

The Port 2 connectors allow components inside the extension unit to be looped into the RF signal path of the network analyzer (NWA) test port 2. The connectors must be connected to the corresponding connectors provided by the NWA option R&S ZVA24-B16 (see [chapter 2.1.3.4, "Rules for RF Connections"](#), on page 12).

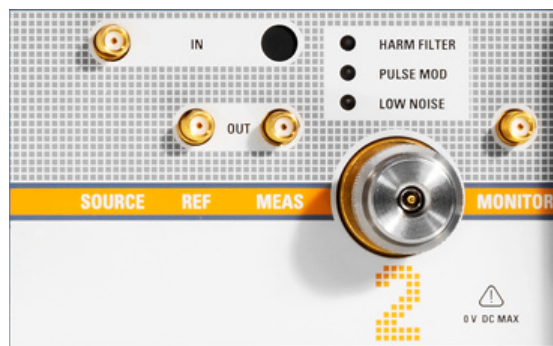

The following connectors are available:

- Two 2.92 mm connectors MEAS IN and MEAS OUT. To modify the test signal measured at analyzer port 2, connect the 2.92 mm connectors as follows:
 - MEAS IN (ZVAX) to MEAS OUT (NWA)
 - MEAS OUT (ZVAX) to MEAS IN (NWA)
- A 2.92 mm MONITOR connector. This connector is intended e.g. for an external spectrum analyzer used to monitor the measured signal.
- Option R&S ZVAX-B292, "High Power Coupler Port 2", provides two additional 2.92 mm connectors labeled SOURCE IN and REF OUT plus a 3.5 mm test port connector PORT 2. The MEAS IN connector is not installed. This option extends the receiver power range to values up to 20 W (+43 dBm) at the PORT 2 connector. The "High Power Coupler Port 2" replaces the internal coupler at the network analyzer port 2. The PORT 2 connector replaces the respective test port connector of the network analyzer. To provide an RF source signal at the PORT 2 connector and measure a high-power input signal at PORT 2, connect the extension unit as follows:
 - SOURCE IN (ZVAX) to SOURCE OUT (NWA). It may be necessary to loop an external isolator with high power termination into this connection in order to prevent the port 2 source of the NWA from being damaged.

- REF OUT (ZVAX) to REF IN (NWA). It may be necessary to loop an external attenuator (at least 33 dB for 43 dBm max power) into this connection.
- MEAS OUT (ZVAX) to MEAS IN (NWA). It may be necessary to loop an external attenuator (at least 33 dB for 43 dBm max power) into this connection.
- 3.5 mm connector (ZVAX) to the output of the DUT

In the figure below, red lines denote signal paths where the power may exceed the maximum input power of the network analyzer.

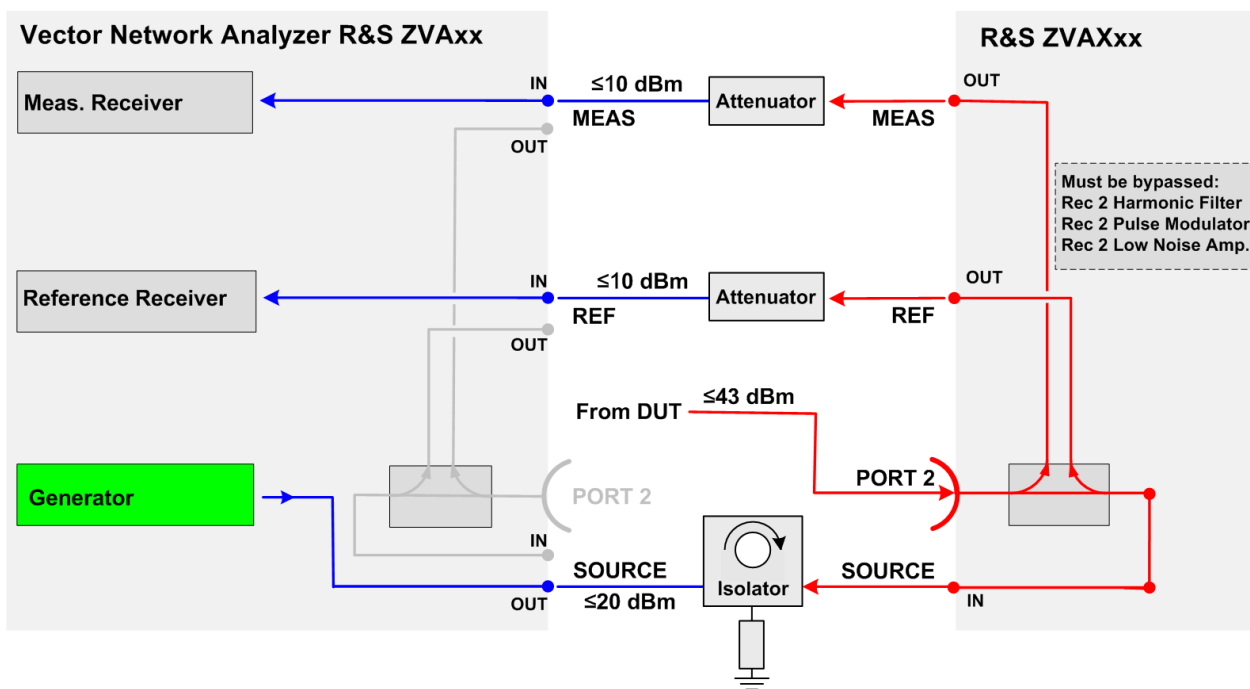

Fig. 2-2: Connection of PORT 2 for high receiver powers

NOTICE

Maximum RF power and DC offset

An input power of +43 dBm is allowed only if none of the options R&S ZVAX-B203, "Low Noise Preamplifier", R&S ZVAX-B252, "Harmonic Filter Source Port 2", and R&S ZVAX-B272, "Pulse Modulator Source Port 2", is switched into the RF measurement signal path of port 2. Refer to the data sheet of your network analyzer.

Please observe the maximum RF output power at PORT 1 and the maximum RF input power at the network analyzer ports (see data sheet). If the DUT provides a high input power at the 3.5 mm test port connector of the extension unit, external attenuators may be needed to prevent an excess input power at REF IN and MEAS IN (NWA).

In addition, it is important that the signal fed in at the 3.5 mm test port connector contains no DC offset, as this may impair the measurements and even cause damage to the R&S ZVA port 2 source.

NOTICE**Input and output power of option R&S ZVAX-B203, "Low Noise Preampfier"**

The power gain of the low noise preampfier is >30 dB. Its maximum output power is below the damage level of the network analyzer ports.

Please observe the maximum input power of the preampfier quoted in the R&S ZVAX24 data sheet. Never use the preampfier in combination with the high power coupler and high input powers at PORT 2 (see [Connection of PORT 2 for high receiver powers](#)).

2.1.3.3 RF Connectors Port 3

The Port 3 connectors allow components inside the extension unit to be looped into the RF signal path of the network analyzer (NWA) test port 3. The connectors must be connected to the corresponding connectors provided by the NWA option R&S ZVA24-B16 (see [chapter 2.1.3.4, "Rules for RF Connections"](#), on page 12).

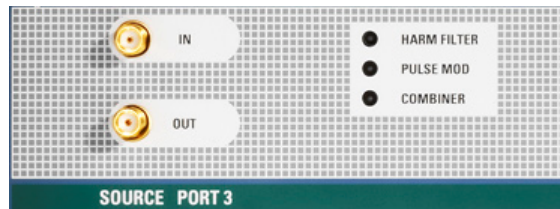

To modify the source signal at analyzer port 3, connect the 2.92 mm connectors as follows:

- SOURCE IN (ZVAX) to SOURCE OUT (NWA). If needed, connect an external amplifier to the PORT 3 SOURCE 2.92 mm connectors on the rear panel to boost the source power.
- SOURCE OUT (ZVAX) to SOURCE IN (NWA)

2.1.3.4 Rules for RF Connections

The following rules simplify the RF connection between the extension unit and the network analyzer (NWA):

- The DUT is connected to the NWA test port connectors (3.5 mm). If a high power coupler is installed at port 1 or port 2 of the extension unit, the test port connector of the coupler replaces the NWA test port connector.
- The 2.92 mm connectors labeled SOURCE of the extension unit are connected to the NWA SOURCE connectors. The same applies to the REF and MEAS connectors.
- XXX OUT connectors of the extension unit (where XXX denotes SOURCE, REF, or MEAS) are connected to XXX IN connectors of the NWA and vice versa.
- If no external components (attenuators, isolators) are looped into the connection, the semirigid jumper cables provided along with the extension unit can be used for all front panel connections between NWA and R&S ZVAX24.

2.2 Rear Panel Tour

The rear panel contains the mains connector with the AC power switch and a fuse holder and several connectors for control and RF signals.



2.2.1 Mains Connector and Switch



The mains connector is located in the lefthand part of the rear panel; see also [chapter 2.3.7, "Power on and off"](#), on page 18.

2.2.2 USB FROM NWA



The type B USB connector (slave USB) is used to control the extension unit from an R&S ZVA24 vector network analyzer. Connect the USB FROM NWA connector to any of the type A USB connectors at the front or rear panel of the analyzer.

A USB control connection is a prerequisite for accessing the ZVAX Path Configuration dialog; see [chapter 3.4, "ZVAX Path Configuration"](#), on page 23.

With an established connection to USB FROM NWA, the type A USB connectors of the extension unit are functionally equivalent to those of the NWA.

NOTICE

USB connection

The length of the connecting USB cable should not exceed 1 m. It is recommended to use the cable delivered with the extension unit.

2.2.3 Master USB Connectors



Two type A USB connectors (master USB), equivalent to the master USB connectors on the front panel; see [chapter 2.1.2, "USB Connectors"](#), on page 7.

2.2.4 FILTER CONTROL IN

For future extensions.



2.2.5 PORT 1 / 2 / 3 SOURCE

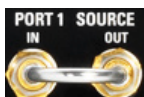

Three pairs of 2.92 mm connectors used to loop external components, e.g. amplifiers, into the source signal paths of test ports 1, 2, and 3. The source signal path of test port 2 does not contain any additional modules; see [figure 3-2](#).

NOTICE

RF emissions

To comply with the emission requirements, always use semirigid cables (preferably, the cables supplied with the extension unit) to connect external components or close the OUT/IN loops.

2.2.6 CASCADE IN



Input connector for pulse generator signals from the R&S ZVA24 network analyzer (with option R&S ZVA-K27). The two pulse generator signals control the pulse modulators in the extension unit (options R&S ZVAX-B271, R&S ZVAX-B272, R&S ZVAX-B273). Refer to the detailed description of the pulse generator in the help system of your network analyzer.



The pulse modulators are controlled either via the CASCADE IN or via the EXT PULSE GENERATOR IN connectors; see [figure 3-3 on page 24](#). The pulse generator signals are also fed to the PULSE GENERATOR OUT connectors. See [chapter 2.2.7, "EXT PULSE GENERATOR IN / OUT"](#), on page 15.

2.2.7 EXT PULSE GENERATOR IN / OUT

Input connector for pulse generator signals from external pulse generators. The two pulse generator signals labeled 1 and 2 can be set to control the pulse modulators in the extension unit (options R&S ZVAX-B271, R&S ZVAX-B272, R&S ZVAX-B273).

The pulse generator signals from the CASCADE IN or the EXT PULSE GENERATOR IN inputs can be fed to the PULSE GENERATOR OUT connectors; see [figure 3-3 on page 24](#).



The pulse modulators are controlled either via the EXT PULSE GENERATOR IN or via the CASCADE IN connector. See [chapter 2.2.6, "CASCADE IN"](#), on page 14.

The pulse PULSE GENERATOR OUT signals are also compatible with external pulse generators with a 50 Ω load impedance.

2.3 Putting the Extension Unit into Operation

This section describes the basic steps to be taken when setting up the extension unit for the first time.

NOTICE

Risk of instrument damage

Before switching on the instrument, make sure that the following conditions are met:

- Instrument casing is in place and all fasteners are tightened.
- All fan openings are unobstructed and the airflow perforations are unimpeded. The minimum distance from the wall is 10 cm.
- The instrument is dry and shows no sign of condensation.
- The instrument is operated in the horizontal position on an even surface.
- The ambient temperature does not exceed the range specified in the data sheet.
- Signal levels at the input connectors are all within the specified ranges.

Failure to meet these conditions may cause damage to the instrument or other devices in the test setup.

2.3.1 Unpacking the Extension Unit

The extension unit is shipped together with its mandatory accessories in a cardboard box.

In order to unpack its contents proceed as follows:

1. Remove the unit from its packaging and check the equipment for completeness using the delivery note and the accessory lists for the various items.
2. First, pull off the polyethylene protection pads from the unit's rear feet and then carefully remove the pads from the unit handles at the front.
3. Pull off the corrugated cardboard cover that protects the rear of the unit.
4. Carefully unthread the cardboard cover at the front that protects the unit handles and remove it.
5. Check the unit for damage. If you notice any damage, immediately contact the carrier who delivered the unit. In this case, make sure not to discard the box and packing material.

It is advisable to keep the original packing material in order to protect the control elements and connectors in case the unit is to be transported or shipped at a later date.

2.3.2 Instrument Setup

The extension unit is designed for use under laboratory conditions, either on a bench top or in a rack.

The general ambient conditions required at the operating site are as follows:

- The ambient temperature must be in the ranges specified for operation and for compliance with specifications (see data sheet).
- All fan openings including the rear panel perforations must be unobstructed. The distance to the wall should be at least 10 cm.

NOTICE

Electrostatic discharge

To avoid damage of electronic components of the DUT and the extension unit, the operating site must be protected against electrostatic discharge (ESD). ESD is most likely to occur when you connect or disconnect the extension unit's test ports.

To prevent ESD damage use the wrist strap and grounding cord supplied with the unit and connect yourself to the GND connector at the front panel.

2.3.3 Bench Top Operation

If the extension unit is operated on a bench top, the surface should be flat. The unit must be used in horizontal position, standing on its feet. It is also possible to place the unit underneath the network analyzer; see [figure 3-1 on page 22](#).

NOTICE**Danger of injury**

The feet may fold in if they are not folded out completely or if the unit is shifted. The feet may break if they are overloaded. Fold the feet completely in or completely out to ensure stability of the unit and personal safety.

To avoid injuries, never shift the unit when its feet are folded out. The overall load (the unit's own weight plus that of the units stacked on top of it) on the folded-out feet must not exceed 500 N.

Place the unit on a stable surface. Secure the units stacked on top of it against slipping (e.g. by locking their feet on the top front frame). When the unit is standing on its folded-out feet, do not work under the unit and do not put anything under it, otherwise injuries or material damage could occur.

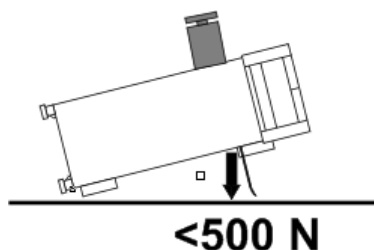

The unit can be used in each of the positions shown below.

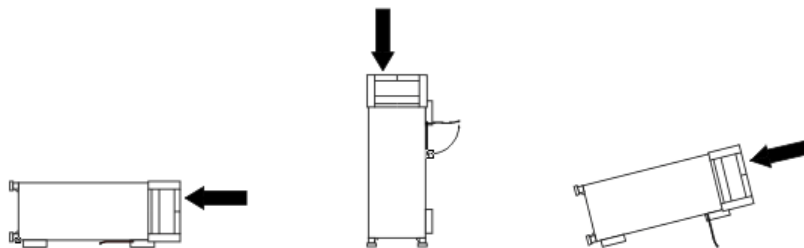

2.3.4 Mounting the Extension Unit in a 19" Rack

The unit can be mounted in 19" racks using the adapter R&S ZZA-211 (order number 1096.3260.00). Mounting instructions are supplied with the rack adapter.

NOTICE**Risk of instrument damage**

For rack installation, make sure that all fan openings are unobstructed and that the airflow perforations are unimpeded. This helps to prevent the instrument from overheating.

2.3.5 EMI Protective Measures

To avoid electromagnetic interference, the unit may only be operated when it is closed and with all shielding covers fitted. Use only appropriate shielded signal and control cables; see [chapter 2.1.3, "RF Connectors"](#), on page 8. Observe the EMI classifications of both the R&S ZVAX24 and the R&S ZVA24 in their data sheets.

NOTICE

Electrostatic discharge

To protect the extension unit against Electrostatic Discharge (ESD) damage use the wrist strap and grounding cord supplied with the network analyzer and connect yourself to the GND connector at the front panel. For details refer to the Quick Start Guide of your analyzer.

2.3.6 Connecting the Extension Unit to the AC Supply

The extension unit is automatically adapted to the AC supply voltage. The supply voltage must be in the range 100 V to 240 V; 50 Hz to 60 Hz. The mains connector is located at the rear panel.

- ▶ Connect the extension unit to the AC power source using the AC power cable delivered with the unit.

The maximum and typical power consumption of the extension unit is listed in the data sheet. The extension unit is protected by two fuses which can be replaced as described in [chapter 2.3.9, "Replacing Fuses"](#), on page 19.

2.3.7 Power on and off

The mains connector and switch is located at the rear panel.

- ▶ To turn the power on or off, press the AC power switch to position I (On) or 0 (Off).

After power-on, the extension unit is in standby or ready state, depending on the state of the standby key at the front panel of the unit.



2.3.8 Standby and Ready State

The standby key connects/disconnects all internal modules of the extension unit to/from the DC supply voltage generated by its internal power supply.



- In standby state (yellow LED on) the power consumption of the unit is very small, however, the internal power supply is still connected to the AC mains power as long as the mains power switch at the rear panel is on.
- In ready state (green LED on) all modules are power-supplied and the unit can be used as described in [chapter 3, "Pulse Profile Measurement"](#), on page 21.

It is recommendable to switch the extension unit to standby state or switch it off by the rear panel AC power switch if it is not used for some time.



Switching on the instruments

Switching on the connected extension unit while the network analyzer is booting can cause problems. It is safe to switch on the R&S ZVAX24 while the R&S ZVA network analyzer is off or in standby mode, or after it has completed its startup procedure. You can also switch on both instruments before you connect the USB control cable.

CAUTION

Shock hazard

The unit is still power-supplied while it is in standby mode.

2.3.9 Replacing Fuses

The mains connector at the rear panel is protected by two fuses IEC127 T3.15 H.

- ▶ To replace the fuses carefully open the lid from the left side and remove the red fuse holder from its shaft. If needed, use a small screwdriver for lifting the fuse holder.

2.4 Maintenance

The R&S ZVAX24 extension unit does not require any special maintenance. Make sure that the air vents are not obstructed. The outside of the unit is suitably cleaned using a soft, lint-free dust cloth.

NOTICE

Instrument damage caused by cleaning agents

Cleaning agents contain substances that may damage the instrument, e.g. cleaning agents that contain a solvent may damage the front panel labeling or plastic parts.

Never use cleaning agents such as solvents (thinners, acetone, etc), acids, bases, or other substances.

The outside of the instrument can be cleaned sufficiently using a soft, lint-free dust cloth.

For our support center address and a list of useful R&S contact addresses refer to the pages at the beginning of this manual.

2.5 Storing and Packing

The extension unit can be stored at the temperature range quoted in the data sheet. When it is stored for a longer period of time the unit should be protected against dust.

The original packing should be used when the unit is to be transported or dispatched. If the original packing is no longer available, use a sturdy cardboard box of suitable size and carefully wrap the unit to protect it against mechanical damage.

3 Pulse Profile Measurement

This chapter describes the use of an R&S ZVA vector analyzer and an R&S ZVAX24 extension unit for creating a pulsed RF signal and performing pulse profile measurements. Other R&S ZVAX24 measurements involve similar measurement stages. For an overview of the R&S ZVAX24 functionality refer to [chapter 4, "Overview of R&S ZVAX24 Options"](#), on page 29.

3.1 Required Equipment

The pulse profile measurement can be carried out with the following equipment:

- Network analyzer (NWA) R&S ZVA24 with a firmware version V2.60 or higher and a motherboard part number 1305.6470.02 (see "Info > Hardware Info ...")
- Option R&S ZVA-K27, "Pulse Generator"
- Option R&S ZVA-K7, "Pulsed Measurements"
- Option R&S ZVA<n>-B16, "Direct Generator/Receiver Access" at source port 1
- One R&S ZVAX24 extension unit equipped with option R&S ZVAX24-B271, "Pulse Modulator Generator Port 1"

3.2 Measurement Principle

The pulse modulator option R&S ZVAX24-B271 provides a pulsed source signal at the NWA port 1. Pulse width and period are determined by the used pulse generator, which can e.g. be the internal pulse generator of the NWA provided by option R&S ZVA-B27. This option also provides a second "Sync" signal that can be used to synchronize the measurement to the rising edge of the generated pulses.

The DUT is connected between the test ports 1 and 2 of the analyzer; the transmitted pulsed signal is measured at port 2 using the analyzer's "Pulse Profile" mode.

The measurement involves the following steps:

1. Connection of the extension unit
2. Configuration of the extension unit for the selected measurement and test setup ("ZVAX Path Configuration")
3. Definition of the pulse generator and the trigger settings
4. Configuration of the "Pulse Profile" mode
5. Calibration
6. Connection of the DUT and measurement

Power calibrations and system error corrections for test setups with an extension unit can be performed in the ordinary way.

3.3 Connecting the Extension Unit

The pulse profile measurement requires the following connections between the network analyzer and the extension unit.

- RF connection: Connect SOURCE IN (ZVAX) to SOURCE OUT (NWA) and SOURCE OUT (ZVAX) to SOURCE IN (NWA). See also [chapter 2.1.3.1, "RF Connectors Port 1"](#), on page 8.
- Control connection: Connect USB FROM NWA (ZVAX) to any of the USB type A connectors at the front or rear panel of the NWA. See also [chapter 2.2.2, "USB FROM NWA"](#), on page 13.
- Pulse generator connection: Connect CASCADE IN (ZVAX) to CASCADE (NWA) using the using the RJ-45 cable supplied with the extension unit. See also [chapter 2.2.6, "CASCADE IN"](#), on page 14.

The DUT is connected between the analyzer ports 1 and 2. The schematic test setup is shown below.

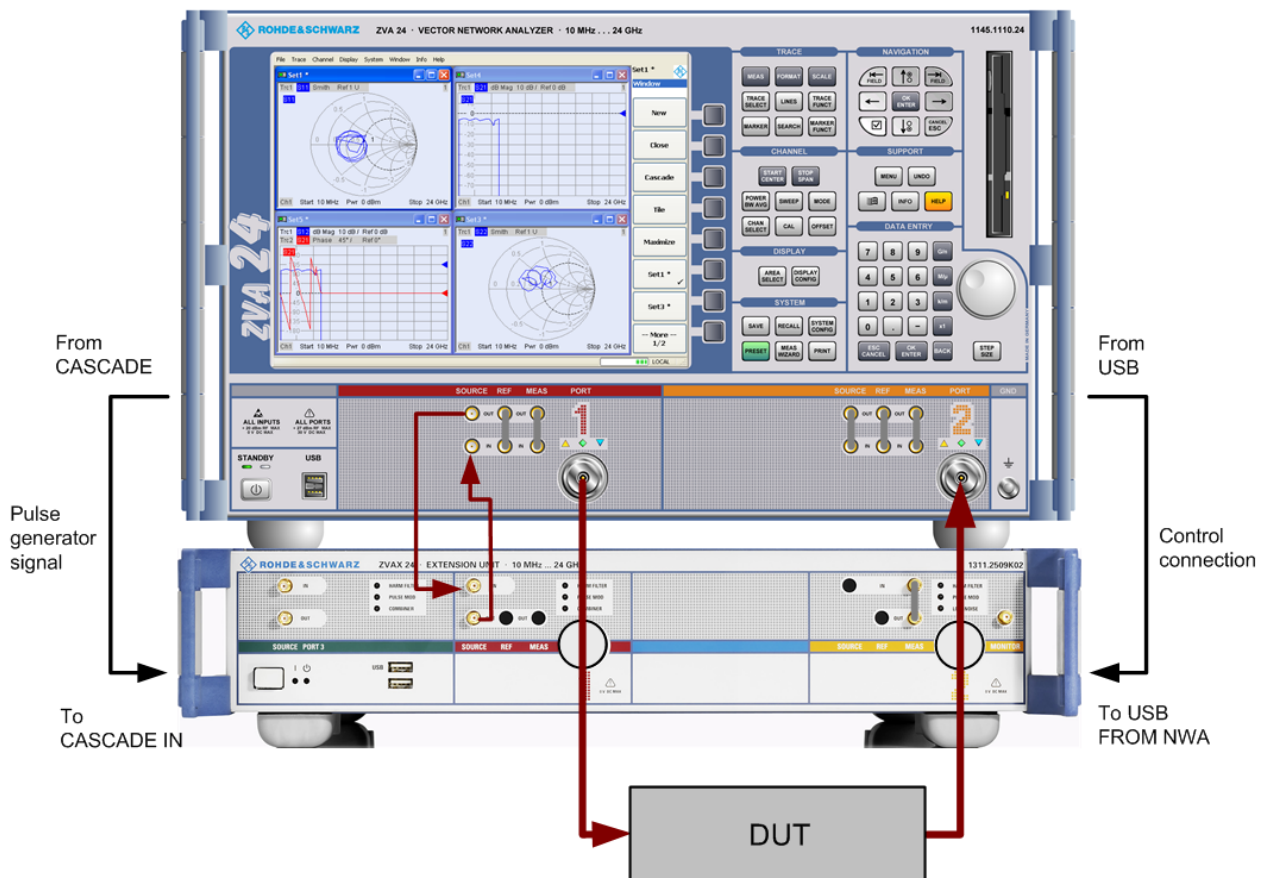

Fig. 3-1: Test setup for pulse profile measurement

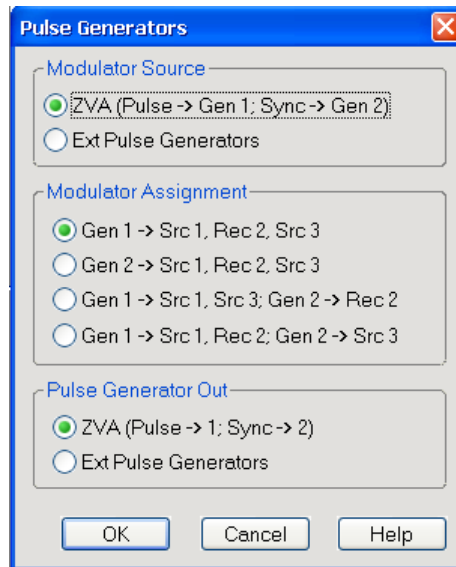

Fig. 3-3: Pulse Generator settings

3.5 Pulse Generator Signals

The pulse generator provides single pulses with defined width and period or sequences of pulses (pulse trains). In the example below, a single pulse with a width of $1.4 \mu\text{s}$ is generated. The pulse is repeated after a pulse period of $5 \mu\text{s}$. The second pulse generator signal ("Sync" signal) can be used to synchronize data acquisition to the pulse.

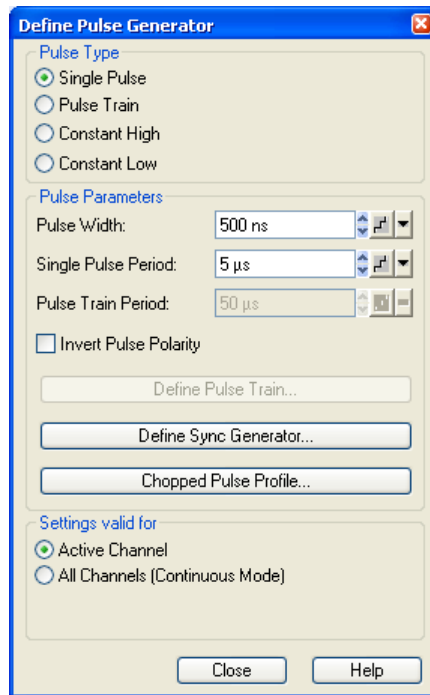

Fig. 3-4: Define Pulse Generator

1. Click "Channel > Sweep > Sweep Type > Pulse Generator" to activate the pulse generator signal.
2. Click "Def Pulse Generator..." and configure the "Pulse Parameters" as shown above.
3. In the "Define Pulse Generator" dialog, click "Define Sync Generator..." and ensure that the "Sync" signal is configured as shown below.

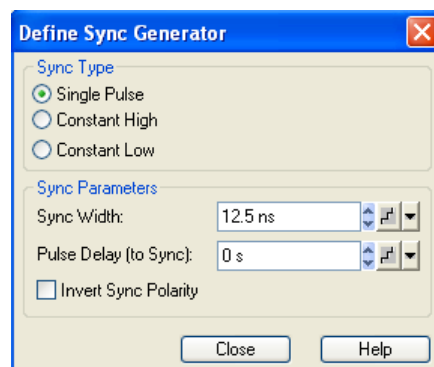

Fig. 3-5: Define Sync Generator

4. Click "Channel > Sweep > Trigger > Pulse Gen..." to select the pulse generator as trigger source.
The dialog "Pulse Gen Trigger" opens. Close it without modifying the default setting ("Rising Edge Sync").

3.6 Pulse Profile Mode

The pulse profile mode of the network analyzer is particularly suited for measurements on pulsed signals. The parameters must be adjusted to the pulse generator settings. In the example below, the start and stop time have been adjusted to view the 1.4 μs pulse width defined previously.

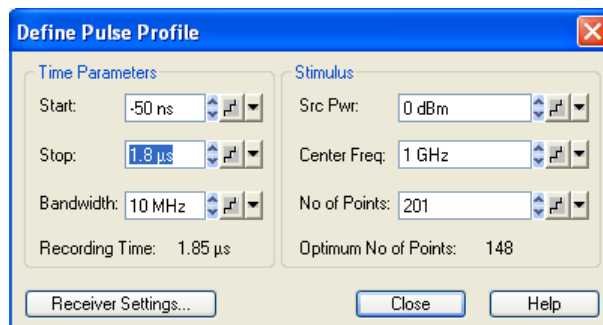

Fig. 3-6: Define Pulse Profile

1. Click "Channel > Sweep > Sweep Type > Pulse Profile" to activate the pulse profile mode.
2. Click "Define Pulse Profile..." and configure the "Time Parameters" as shown above.



The R&S ZVA help system provides detailed information about the pulse profile mode including measurement examples.

3.7 Calibration

The source signal from port 1 is attenuated on its way through the R&S ZVAX24 extension unit. The unit stores a number of power correction data sets to account for the effects of the different modules and signal paths in the extension unit. Whenever a new R&S ZVAX24 configuration is defined the analyzer modifies its own factory power correction data using the appropriate data set from the unit (see [chapter 3.4, "ZVAX Path Configuration"](#), on page 23).

The active modified factory power correction data set is replaced when the user performs his own power calibration. Power calibrations and system error corrections for test setups with an extension unit can be made in the ordinary way.

3.8 Measurement

After power calibration and system error correction, the pulsed measurement can be performed as outlined in [chapter 3.6, "Pulse Profile Mode"](#), on page 26. All measured

quantities (S-parameters, wave quantities, ratios etc.) and other trace settings are available.

The following example shows the reflected wave a_1 , the transmitted wave b_2 , and the forward transmission coefficient S_{21} of a DUT with the settings of the previous sections.

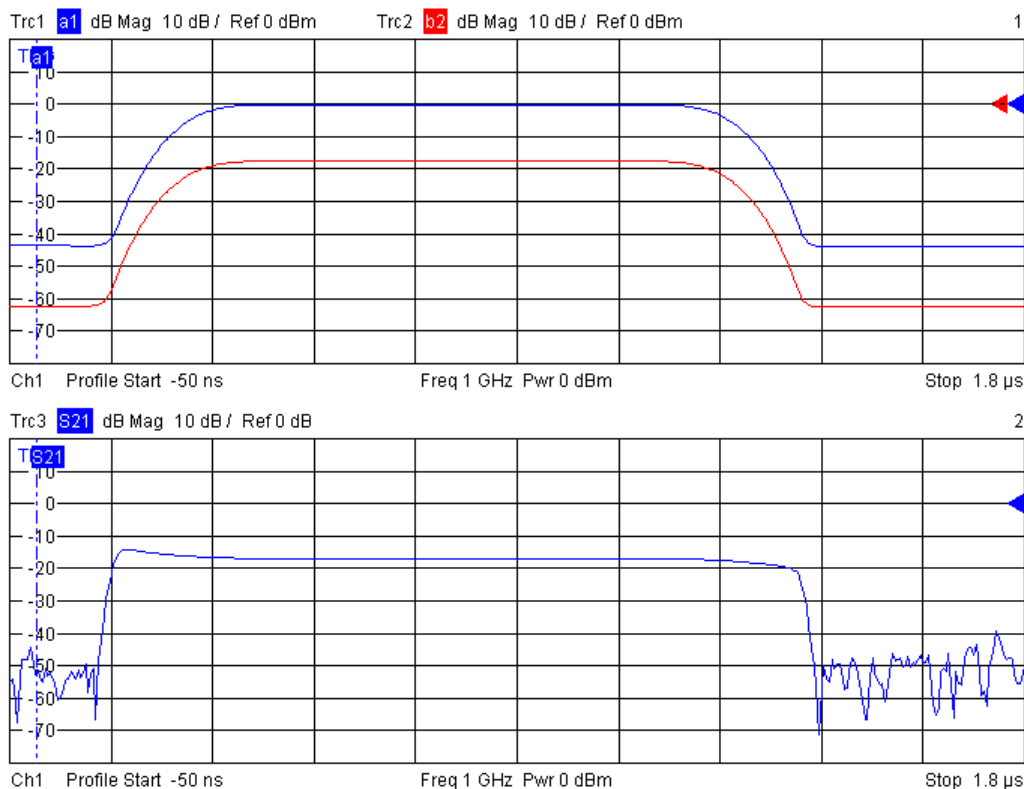

Fig. 3-7: Example for pulse profile measurement

It can be seen that the steepness of the edges of the S_{21} pulse arises from ratioing (b/a) and does not provide a measure for the rise and fall times of the pulse itself.

3.9 Possible Extensions

The extension unit R&S ZVAX24 can accommodate up to three pulse modulators (for two source paths and a receiver path) plus a variety of other hardware options. Options installed internally are shown in the "ZVAX Path Configuration" dialog (figure 3-3). An arbitrary combination of options may be used simultaneously.

For an overview of R&S ZVAX24 options and their use refer to [chapter 4, "Overview of R&S ZVAX24 Options"](#), on page 29.

3.10 Additional Information

For a comprehensive description of the measurement dialogs related to the R&S ZVAX24 including remote control refer to the R&S ZVA online help system or to the printable operating manual, which is available for download at <http://www.rohde-schwarz.com/product/zva>.

4 Overview of R&S ZVAX24 Options

The following table lists the options to be installed in the extension unit and possible applications.

Option	Type	Application
Low Noise Preamplifier	R&S ZVAX-B203	Amplifies the input signal at port 2 of the network analyzer. This reduces the noise figure of the NWA receiver and thus improves the accuracy of a noise figure measurement with option R&S ZVAB-K30.
Port 2 Receiver Monitor Output	R&S ZVAX-B210	The measured test signal at port 2 is fed to the MONITOR connector on the R&S ZVAX24 front panel. An external device (e.g. a spectrum analyzer) can be connected to monitor the signal.
Combiner	R&S ZVAX-B211	Combines the source signals from ports 1 and 3. With different port frequencies, the combiner provides a two-tone signal, e.g. for intermodulation or mixer delay measurements.
Harmonic Filter Source Port 1	R&S ZVAX-B251	Provides an RF source signal with excellent harmonic suppression at port 1. To be used for accurate harmonics measurements.
Harmonic Filter Receiver Port 2	R&S ZVAX-B252	Suppresses the fundamental wave in the received signal at port 2 and therefore prevents the generation of additional harmonics in the NWA receiver. To be used for accurate harmonics measurements.
Harmonic Filter Source Port 3	R&S ZVAX-B253	Provides an RF source signal with excellent harmonic suppression at port 3. Harmonic filters for two independent source signals can be used for differential measurements and mixer measurements which require RF and LO signals with a high spectral purity.
Pulse Modulator Source Port 1	R&S ZVAX-B271	Provides pulsed signals at port 1. To be used for pulsed measurements on unidirectional DUTs (e.g. power amplifiers), where the reverse stimulus signal can be continuous.
Pulse Modulator Receiver Port 2	R&S ZVAX-B272	Modifies the pulsed received wave at port 2. Used to protect the NWA receiver from excess input levels (e.g. in T/R module measurements) and for the chopped pulse profile measurement mode.
Pulse Modulator Source Port 3	R&S ZVAX-B273	Provides pulsed signals at port 3. Pulsed signals at two source ports are used for pulsed measurements on DUTs which require pulsed stimulus signals in forward and reverse direction (e.g. bidirectional DUTs like T/R modules for phased-array pulse radar).
High Power Coupler Port 1	R&S ZVAX-B291	Extends the source power range at port 1 to values up to +43 dBm. Used for measurements on DUTs that require high stimulus powers.
High Power Coupler Port 2	R&S ZVAX-B292	Extends the receiver power range at port 2 to values up to +43 dBm. Used for measurements on DUTs that provide high output powers.

Index

A

AC supply 18

C

Calibration 26
 CASCADE IN 14
 Connection (for pulse profile meas.) 22

D

Define Pulse Generator 24
 Define Pulse Profile 26
 Define Sync Generator 25

E

Electrostatic discharge 16
 EMI 18
 EXT PULSE GENERATOR IN 15

F

FILTER CONTROL IN 14
 Front panel 7
 Fuses 19

M

Mains connector 13
 Maintenance 19
 Measurement 26
 Measurement example 21
 Measurement principle 21

O

Options (overview) 29

P

Packing 20
 PORT 1 / 2 / 3 SOURCE 14
 Power calibration 26
 Power on/off 18
 Power supply 18
 Pulse generator 24
 PULSE GENERATOR OUT 15
 Pulse Generators 24
 Pulse profile measurement 21

R

R&S ZVAX-B203 ... R&S ZVAX-B292 29
 Rack (19") 17
 Rear panel 13
 Required equipment 21
 RF connection rules 12
 RF connectors
 port 1 8
 port 2 10
 port 3 12

S

Safety instructions 5
 Setup 16
 Standby key 7
 Standby vs. ready 18
 Storing 20
 Sync signal 24
 System error correction 26

U

Unpacking the instrument 15
 USB (type A) 8, 14
 USB FROM NWA 13

Z

ZVAX Path Configuration 23